

LEDVANCE Lamps

SubstiKIT™ LED T8 Type C System

Application

SubstiKIT LED T8 Type C System pairs a dimmable direct current external driver with LED lamps. In applications utilizing multiple lamps, the external driver automatically adjusts the output current to avoid over driving remaining lamps and thus ensuring reliable system performance. It also provides 12Vdc auxiliary output that enables easy addition of wired/wireless controls and sensors to a project. That will not only maximize energy savings, but will provide high quality light for office, education, and retail applications.

Benefits and Features

- Select external drivers work with LEDVANCE LINK™ controls and sensors or other equivalent controls
- Available in 2ft, 3ft, 4ft linear and U-Bend options
- Includes RJ11 connector with lead wires for easy and quick installation for 0-10V dimming controls
- Dimmable down to 10% with dedicated Type C 0-10V driver to maximize energy savings and optimize light levels
- See System Data section below for DLC approved systems
- No warm-up time, instant-on with full light output and stable lamp-to-lamp color
- No UV emission
- System Efficacy up to 160 LPW
- 3000K, 3500K, 4100K, 5000K color temperatures
- CRI >80
- Beam angle: 200° with frosted glass optics
- Light Emitting Angle: 340°

Electrical

- Compatible with direct current dimmable SubstiKIT LED driver with input voltage of 120-277V per system table
- Power Factor >0.9
- THD <20%
- Dimmable (0-10V)

Rated Life

- 50,000 hours (L₇₀)*

*4ft lamps have 70,000hrs (L₇₀) at 40°C operating temperature.



Wattage Comparison

Traditional Source	Traditional System Wattage	LED System Wattage	Energy Savings
2ft 17W T8 w/QHE 2X32T8/UNV ISN-SC	29	18	38%
3ft 25W T8 w/ QHE 2X32T8/UNV ISN-IC	43	23	47%
4ft 32W T8 w/QHE 2X32T8/UNV ISN-SC	55	23	58%
4ft 32W T8 w/QHE 2X32T8/UNV ISN-SC	55	27	51%
Ubend T8 w/ QHE 2X32T8/UNV ISN-IC	55	30	45%

Warranty

- System (external direct-current driver & lamps) is covered by a 5-year limited warranty. For additional details, please visit www.ledvanceUS.com/warranty
- NLB Trusted Warranty Program

Operating Temperature

- -4°F to +113°F (-20°C to +45°C)

Max Case Temperature

- 167°F (75°C)

Certifications and Listings

- cETLus
- RoHS
- FCC
- NSF
- DLC 5.1

Installation

- Please refer to the Installation manual included inside the packaging and the applications information listed below for more information.



Specification Data

Catalog #	Type
Project	
Comments	
Prepared by	

Ordering Guide (Lamps)

LED	XX	T8	LXX	FG	DIM	8	XX	DC	XXX
Product Name	Wattage	Lamp Type	Length	FG = Frosted Glass	DIM = Dimmable	8 = 82	Color Temperature	DC = DC Driver External Type C	Driver Output Current/Channel
LED	8 = 8 Watts 10 = 10.5 Watts 12 = 12 Watts 13 = 13.5 Watts	T8	L24 = 24 Inch L36 = 36 Inch L48 = 48 Inch U = U Bend				30 = 3000K 35 = 3500K 41 = 4100K 50 = 5000K		170 = 170 mA (8W/2ft) 220 = 220 mA (10.5W/3ft, 4ft) 255 = 255 mA (12W/4ft) 280 = 280 mA (13.5W/UBend)

Ordering Information (Lamps)

Item Number	Ordering Abbreviation	Lamp Length	Lamp Power (W)	Initial Lumens (lm)	Bare Lamp Efficacy (LPW)	CCT	CRI	Lens Material	Life (L70) Hours	Beam Angle (°)	Package Qty
41934	LED8T8L24FGDIM830DC170	2ft	8	1100	138	3000	82	Frosted Glass	50,000	200	25
41935	LED8T8L24FGDIM835DC170	2ft	8	1100	138	3500	82	Frosted Glass	50,000	200	25
41936	LED8T8L24FGDIM841DC170	2ft	8	1100	138	4100	82	Frosted Glass	50,000	200	25
41937	LED8T8L24FGDIM850DC170	2ft	8	1100	138	5000	82	Frosted Glass	50,000	200	25
41938	LED10T8L36FGDIM830DC220	3ft	10.5	1380	131	3000	82	Frosted Glass	50,000	200	25
41939	LED10T8L36FGDIM835DC220	3ft	10.5	1380	131	3500	82	Frosted Glass	50,000	200	25
41940	LED10T8L36FGDIM841DC220	3ft	10.5	1450	138	4100	82	Frosted Glass	50,000	200	25
41941	LED10T8L36FGDIM850DC220	3ft	10.5	1450	138	5000	82	Frosted Glass	50,000	200	25
41942	LED10T8L48FGDIM830DC220	4ft	10.5	1725	164	3000	82	Frosted Glass	50,000	200	25
41943	LED10T8L48FGDIM835DC220	4ft	10.5	1850	176	3500	82	Frosted Glass	50,000	200	25
41944	LED10T8L48FGDIM841DC220	4ft	10.5	1850	176	4100	82	Frosted Glass	50,000	200	25
41945	LED10T8L48FGDIM850DC220	4ft	10.5	1850	176	5000	82	Frosted Glass	50,000	200	25
41946	LED12T8L48FGDIM830DC255	4ft	12	2050	171	3000	82	Frosted Glass	50,000	200	25
41947	LED12T8L48FGDIM835DC255	4ft	12	2200	183	3500	82	Frosted Glass	50,000	200	25
41948	LED12T8L48FGDIM841DC255	4ft	12	2200	183	4100	82	Frosted Glass	50,000	200	25
41949	LED12T8L48FGDIM850DC255	4ft	12	2200	183	5000	82	Frosted Glass	50,000	200	25
41950	LED13T8UF8DIM830DC280	UBend	13.5	2050	152	3000	82	Frosted Glass	50,000	200	10
41951	LED13T8UF8DIM835DC280	UBend	13.5	2200	163	3500	82	Frosted Glass	50,000	200	10
41952	LED13T8UF8DIM841DC280	UBend	13.5	2200	163	4100	82	Frosted Glass	50,000	200	10
41953	LED13T8UF8DIM850DC280	UBend	13.5	2200	163	5000	82	Frosted Glass	50,000	200	10

Ordering Guide (Drivers)

LEDvr	X-XL	TLED	XXX	XX-XXW	DIM	LINK
Product Name	Number of Lamps	Lamp Type	Input Voltage	Wattage Range on DIP Switch	DIM = Dimmable	LINK = Wireless Control
LEDVANCE Driver	1-2L = 1 or 2 Lamps 1-3L = 1 or 3 Lamps 3-4L = 3 or 4 Lamps	LED Tubes (Type C)	UNV = 120-277V 347V = 347V	9-30W = 9W min to 30W max 9-40W = 9W min to 40W max 27-54W = 27W min to 54W max 27-60W = 27W min to 60W max		

Ordering Information (Drivers)

Item Number	Ordering Abbreviation	Driver Input				Driver Output					
		Input Voltage (Vac)	Power Factor @ Full Load	THD @ Full Load	System Input Power (W)	Frequency (Hz)	Inrush Current Peak (A) @277V	Output Voltage (Voc)	0-10V Dimming	Wireless Control	Package Qty
75846	LEDvr1-2LTLEDUNV9-30WDIM	120-277	0.9	20%	9-30W	50/60	5	48	10%–100%	No	25
75847	LEDvr3-4LTLEDUNV27-60WDIM	120-277	0.9	20%	27-60W	50/60	32	48	10%–100%	No	25
75881	LEDvr1-2LTLEDUNV9-30WDIM-LINK	120-277	0.9	20%	9-30W	50/60	5	48	10%–100%	LINK	25
75882	LEDvr3-4LTLEDUNV27-60WDIM-LINK	120-277	0.9	20%	27-60W	50/60	32	48	10%–100%	LINK	25
75848	LEDvr1-3LTLED347V9-40WDIM-LINK	347	0.9	20%	9-40W	50/60	5	48	10%–100%	LINK	25
75849	LEDvr3-4LTLED347V27-54WDIM-LINK	347	0.9	20%	27-54W	50/60	32	48	10%–100%	LINK	25

Physical Information (Lamps)

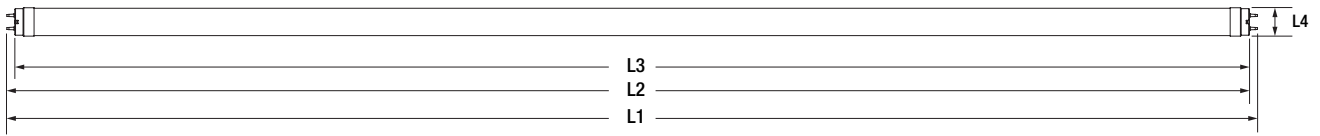

Lamp Description	L1 End of Base Pin to End of Opposite Pin End	L2 Base Face to Opposite Base Pin	L3 Base Face to Base Face	L4 Bulb Outside Diameter
LED8T8L24FGDIM8XXDC170	23.72" ± 0.055 " (602.6mm ± 1.4 mm)	23.45" ± 0.05 " (595.65mm ± 1.25 mm)	Max 23.22" (589.8mm)	1.02" ± 0.08 " (25.9mm ± 2.0 mm)
LED10T8L36FGDIM8XXDC220	35.72" ± 0.055 " (907.4mm ± 1.4 mm)	35.45" ± 0.05 " (900.45mm ± 1.25 mm)	Max 35.22" (894.6mm)	1.02" ± 0.08 " (25.9mm ± 2.0 mm)
LED10T8L48FGDIM8XXDC220	47.725" ± 0.055 " (1212.2mm ± 1.4 mm)	47.45" ± 0.05 " (1205.25mm ± 1.25 mm)	Max 47.22" (1199.4mm)	1.02" ± 0.08 " (25.9mm ± 2.0 mm)
LED12T8L48FGDIM8XXDC255	47.725" ± 0.055 " (1212.2mm ± 1.4 mm)	47.45" ± 0.05 " (1205.25mm ± 1.25 mm)	Max 47.22" (1199.4mm)	1.02" ± 0.08 " (25.9mm ± 2.0 mm)

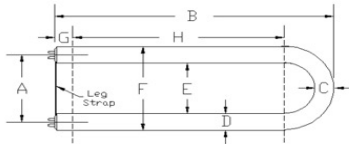

Lamp Description	A Lamp Legs, center to center End of Opposite Pin End	B Base Face to Lamp End	C Bulb Diameter in Bend	D Bulb Diameter in Legs
LED13T8UFGDIM8XXDC280	6" (152mm)	22.6" (574mm)	Max 1.15" (29.2mm)	1.10" (27.9mm)

Physical Information (Drivers)

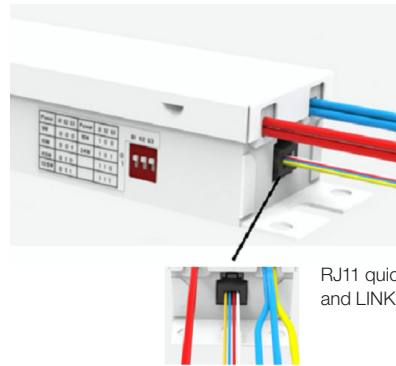
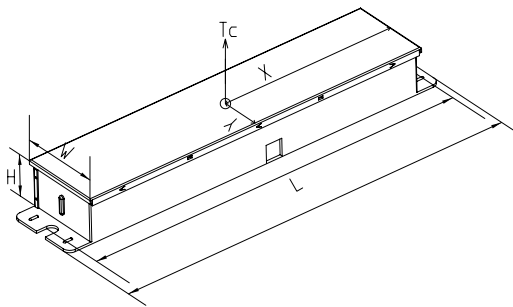

RJ11 quick connect for 0-10V controls and LINK wireless controls

Product Description	L x W x H Length x Width x Height	Mounting	Wiring Diagram
LEDvr1-2LTLEDUNV9-30WDIM	9.45" x 1.62" x 1.22" (240mm x 43mm x 31mm)	3.54" x 0.85" (90mm x 21.6mm)	A & C
LEDvr1-2LTLEDUNV9-30WDIM-LINK			
LEDvr3-4LTLEDUNV27-60WDIM	9.45" x 1.62" x 1.22" (240mm x 43mm x 31mm)	3.54" x 0.85" (90mm x 21.6mm)	B & D
LEDvr3-4LTLEDUNV27-60WDIM-LINK			
LEDvr1-3LTLED347V9-40WDIM-LINK	9.45" x 1.62" x 1.22" (240mm x 43mm x 31mm)	3.54" x 0.85" (90mm x 21.6mm)	A, B & C
LEDvr3-4LTLED347V27-54WDIM-LINK	9.45" x 1.62" x 1.22" (240mm x 43mm x 31mm)	3.54" x 0.85" (90mm x 21.6mm)	B & D

Wiring Diagram A

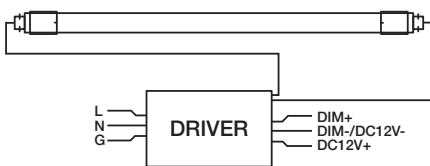

Wiring Diagram B

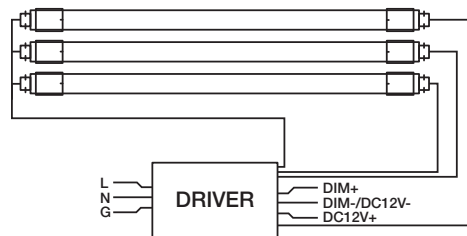

Wiring Diagram C

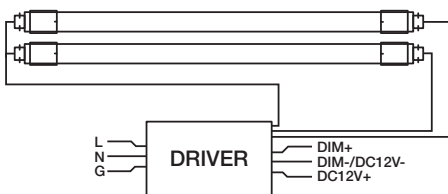

Wiring Diagram D

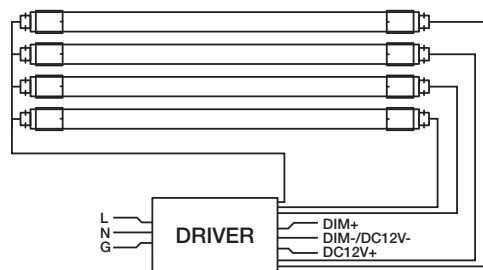

System Data (Drivers)

Driver Description	Lamp Description	Number of Lamps	System Wattage (W)	System Lumens (lm) @4100K	System Efficacy (LPW)	DLC
LEDvr1-2LTLEDUNV9-30WDIM	LED8T8L24FGDIM8XXDC170	1	9	1100	122	No
		2	18	2200	122	5.1
LEDvr1-2LTLEDUNV9-30WDIM-LINK*						
LEDvr1-3LTLED347V9-40WDIM-LINK*						
LEDvr3-4LTLEDUNV27-60WDIM	LED8T8L24FGDIM8XXDC170	3	27	3300	122	5.1
		4	36	4400	122	5.1
LEDvr3-4LTLEDUNV27-60WDIM-LINK*						
LEDvr1-3LTLED347V9-40WDIM-LINK*						
LEDvr3-4LTLED347V27-54WDIM-LINK*						
LEDvr1-2LTLEDUNV9-30WDIM	LED8T8L24FGDIM8XXDC170	1	11.5	1450	126	No
		2	23	2900	126	5.1
LEDvr1-2LTLEDUNV9-30WDIM-LINK*						
LEDvr1-3LTLED347V9-40WDIM-LINK*						
LEDvr3-4LTLEDUNV27-60WDIM	LED10T8L36FGDIM8XXDC220	3	34.5	4350	126	5.1
		4	46	5800	126	5.1
LEDvr3-4LTLEDUNV27-60WDIM-LINK*						
LEDvr1-3LTLED347V9-40WDIM-LINK*						
LEDvr3-4LTLED347V27-54WDIM-LINK*						
LEDvr1-2LTLEDUNV9-30WDIM	LED10T8L48FGDIM8XXDC220	1	11.5	1850	160	No
		2	23	3700	160	5.1
LEDvr1-2LTLEDUNV9-30WDIM-LINK*						
LEDvr1-3LTLED347V9-40WDIM-LINK*						
LEDvr3-4LTLEDUNV27-60WDIM	LED10T8L48FGDIM8XXDC220	3	34.5	5175	160	5.1
		4	46	7400	160	5.1
LEDvr3-4LTLEDUNV27-60WDIM-LINK*						
LEDvr1-3LTLED347V9-40WDIM-LINK*						
LEDvr3-4LTLED347V27-54WDIM-LINK*						
LEDvr1-2LTLEDUNV9-30WDIM	LED12T8L48FGDIM8XXDC255	1	13.5	2200	160	No
		2	27	4400	160	5.1
LEDvr1-2LTLEDUNV9-30WDIM-LINK*						
LEDvr1-3LTLED347V9-40WDIM-LINK*						
LEDvr3-4LTLEDUNV27-60WDIM	LED12T8L48FGDIM8XXDC220	3	40.5	6600	160	5.1
		4	54	8800	160	5.1
LEDvr3-4LTLEDUNV27-60WDIM-LINK*						
LEDvr1-3LTLED347V9-40WDIM-LINK*						
LEDvr3-4LTLED347V27-54WDIM-LINK*						
LEDvr1-2LTLEDUNV9-30WDIM	LED13T8UFGDIM8XXDC280 [†]	1	15	2200	147	No
		2	30	4400	147	5.1
LEDvr1-2LTLEDUNV9-30WDIM-LINK*						
LEDvr3-4LTLEDUNV27-60WDIM	LED13T8UFGDIM8XXDC280 [†]	3	45	6600	147	No
		4	60	8800	147	No
LEDvr3-4LTLEDUNV27-60WDIM-LINK						No

*DLC 5.1 is pending for these drivers.

[†]U-bend lamps are not compatible with 347V input drivers.

Accessories for LEDVANCE LINK Control System (Optional)

Item Number	Model Number	Description
62630	WPPA102-AUX	Bluetooth Controller
62633	EFS107 + RC01	Bluetooth Daylight Harvesting and PIR Motion Sensor
62634	EFS106 -AUX with Lenses	Bluetooth Daylight Harvesting and PIR Motion Sensor

Click here for additional information: <https://www.ledvanceus.com/products/controls/Field-installable-controls/Pages/control-components.aspx>



62630



62633



62634

Application Information

1. These LED lamps require an external driver and are intended to be used with LEDVANCE branded direct-current drivers included in this specification as a UL Approved Type C System.
2. All installation, inspection, and maintenance of lighting fixtures should be done with the power to the fixture turned off. Lamps should be installed and operated in compliance with the National Electrical Code (NEC), Underwriters Laboratories Inc. (UL) requirements, and all applicable codes and regulations.
3. EM ballast that operates with fluorescent ballasts must be disconnected from the lamps.
4. Ensure lamp holders/sockets are in good operating condition before installation.
5. Please do not install LED lamps and fluorescent lamps in the same fixture.
6. Insert and align tubes properly in lamp holders. Partial insertion results in a poor or intermittent electrical contact that can result in short lamp life and arcing. Arcing at the lamp holder can result in localized overheating.
7. Approved for use with shunted or non-shunted lamp holders.
8. Best practice: cap off the remaining ballast wires should the ballast be left in the fixture after disconnecting.
9. To prevent wiring damage or abrasion, do not expose wiring to edges of sheet metal or other sharp objects. Do not make or alter any open holes in an enclosure of wiring or electrical components during kit installation.
10. Refer to the label on the driver for proper DIP switch arrangement for appropriate lamp power.
11. Do not use 3-4 lamp driver to operate less than 3 lamps.
12. U-bend lamps are not compatible with 347V drivers.
13. Operating temperature range between -4°F and 113°F (-20°C and 45°C).
14. Storage temperature range between -4°F and 176°F (-20°C and 80°C).
15. Suitable for use in dry and damp environments.
16. Suitable for open and enclosed fixtures.
17. Please read all installation instructions before attempting installation.
18. For detailed warranty information, please see www.ledvanceUS.com.

LEDVANCE LLC
181 Ballardvale Street, Suite 203
Wilmington, MA 01887 USA
Phone 1-800-LIGHTBULB (1-800-544-4828)
www.ledvanceUS.com

SYLVANIA and LEDVANCE are registered trademarks.
All other trademarks are those of their respective owners.
Licensee of product trademark SYLVANIA in general lighting.
Specifications subject to change without notice.

