



# Uphoria™ PRO LED MR16

## LED MR16 with High Candela (90+ CRI)

With the fit, form, and function of traditional MR16 lamps, these 90+CRI Uphoria™ PRO LED MR16 lamps have a unique optical design that delivers high candela. The COB design ensures excellent uniformity of light from the emitting surface. As such, the dimmable Uphoria PRO LED MR16 lamps deliver crisper, cleaner shadows.

Available in 7W, these lamps provide up to 83% savings on energy costs. These LED MR16 lamps are damp location rated and UL 1993 rated for totally enclosed fixtures.

All Uphoria PRO LED MR16 lamps operate on 12V and are available in either a Soft White (2700K) or a Warm White (3000K) color temperature. These are available in spot, narrow flood, and flood beam angles. Ushio America is proud to stand behind these ENERGY STAR® certified LED lamps with a 3-year limited warranty.



High CRI



Dimmable



ENERGY STAR



UL LISTED



FC



RoHS COMPLIANT

## FEATURES & BENEFITS

- High Candela
- High Color Rendering (90+ CRI)
- COB for Crisper, Cleaner Shadows
- Smooth, Uniform Dimming
- Suitable for Use in Recessed Fixtures
- UL Rated for Totally Enclosed Fixtures (UL 1993)
- Direct Replacement for Traditional MR16 GU5.3 Lamps
- 25,000 Hours Rated Life
- Damp Location Rated
- Application Friendly: UV Free & IR Free
- Environmentally Friendly: Mercury Free, Lead Free and RoHS Compliant
- 3-Year Limited Warranty

## APPLICATIONS

- Track Lighting
- Recessed Lighting
- Accent Lighting
- Art Gallery & Museum Lighting
- Hospitality Lighting

# SPECIFICATIONS

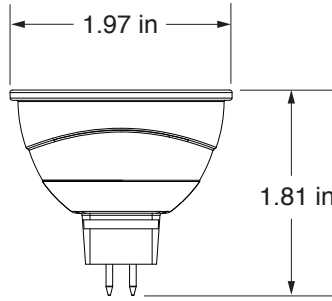

**GU5.3 Base**

**Case Quantity: 12**

Watts (W)	Ordering Code	Lamp Description	Volts (V)	Color Temp (K)	Beam Angle	Lumens* (lm)	CBCP* (cd)	CRI	Rated** (h)
7	1004522	★ UPHORIA PRO LED MR16, SP15, SW27, 90+CRI	12	2700	15°	430	3410	90+	25,000
7	1004524	★ UPHORIA PRO LED MR16, SP15, WW30, 90+CRI	12	3000	15°	430	3422	90+	25,000
7	1004523	★ UPHORIA PRO LED MR16, NFL25, SW27, 90+CRI	12	2700	25°	430	2210	90+	25,000
7	1004436	★ UPHORIA PRO LED MR16, NFL25, WW30, 90+CRI	12	3000	25°	480	2225	90+	25,000
7	1004434	UPHORIA PRO LED MR16, FL40, SW27, 90+CRI	12	2700	40°	480	1064	90+	25,000
7	1004435	UPHORIA PRO LED MR16, FL40, WW30, 90+CRI	12	3000	40°	480	1193	90+	25,000

\* Photometric data is based on LM-79 tests.

\*\* Average life based on 70% lumen maintenance. LM-80 data available.

★**ENERGY STAR® Certified**  
Not compliant with California Title 20.  
Discontinued - For Reference Only

## Electrical Specifications:

Driver: High Efficiency

Power Factor: > 0.9

Power Factor NFL > 0.8

Dimming: See [www.ushio.com](http://www.ushio.com) for dimmer compatibility options.

## CAUTIONS:

Suitable for dry and damp locations.

Suitable for use in recessed fixtures.

Suitable for use in totally enclosed fixtures (UL 1993).

Not for use in emergency or exit lighting.

# PHOTOMETRICS & SPECTRAL DISTRIBUTION CHARTS

## Photometrics

### 2700K

**Item 1004522**

$\theta$ (ft)	H(ft)	E(fc)
0.83	3.3	197.43
1.67	6.6	49.36
2.50	9.9	21.94
3.34	13.2	12.34
4.17	16.5	7.90
15°		7W
7W LED MR16, SP15, SW27		

**Item 1004523**

$\theta$ (ft)	H(ft)	E(fc)
1.24	3.3	210.19
2.47	6.6	52.55
3.71	9.9	23.35
4.94	13.2	13.14
6.18	16.5	8.41
25°		7W
7W LED MR16, NFL25, SW27		

**Item 1004434**

$\theta$ (ft)	H(ft)	E(fc)
2.10	3.3	98.00
4.20	6.6	24.52
6.30	9.9	10.90
8.40	13.2	6.13
10.52	16.5	3.92
40°		7W
7W LED MR16, FL40, SW27		

### 3000K

**Item 1004524**

$\theta$ (ft)	H(ft)	E(fc)
0.88	3.3	314.23
1.75	6.6	78.56
2.62	9.9	34.91
3.50	13.2	19.64
4.37	16.5	12.57
15°		7W
7W LED MR16, SP15, WW30		

**Item 1004436**

$\theta$ (ft)	H(ft)	E(fc)
1.24	3.3	204.32
2.47	6.6	51.08
3.71	9.9	22.70
4.94	13.2	12.77
6.18	16.5	8.17
25°		7W
7W LED MR16, NFL25, WW30		

**Item 1004435**

$\theta$ (ft)	H(ft)	E(fc)
2.10	3.3	109.55
4.10	6.6	27.39
6.20	9.9	12.17
8.20	13.2	6.85
10.30	16.5	4.38
40°		7W
7W LED MR16, FL40, WW30		

## Spectral Distribution Charts

### 2700K

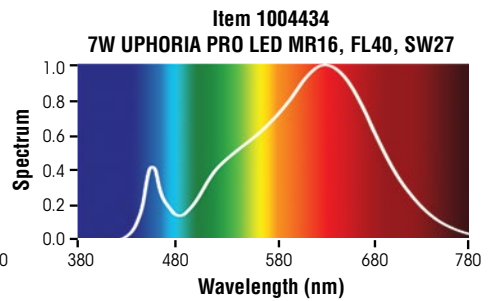
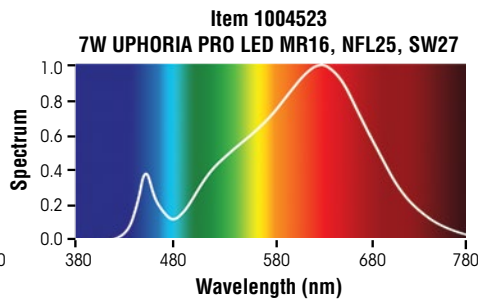
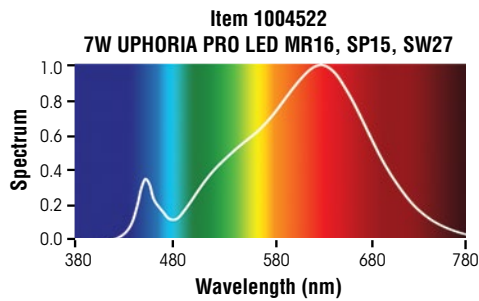

### 3000K

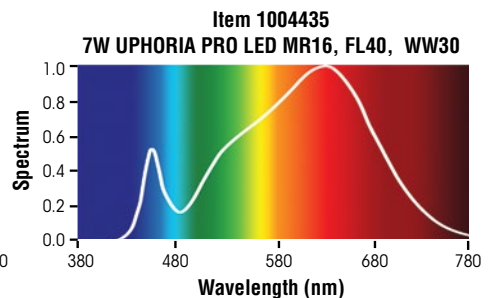
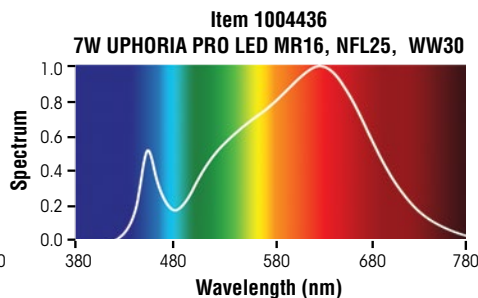
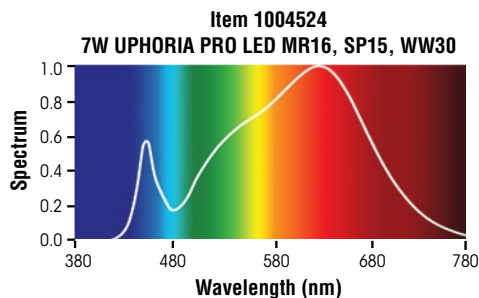

# LIGHTING FACTS

2700K

Item 1004522  
7W LED MR16, SP15, SW27

<b>Lighting Facts/ Faits d'éclairage</b>	
Per Bulb/Par l'ampoule	
<b>Brightness/Luminosité</b>	<b>430 lumens</b>
<b>Estimated Yearly Energy Cost/ Coût énergétique annuel estimé</b>	<b>\$0.84</b>
Based on 3 hrs/day, 11¢/kWh. Cost depends on rates and use. /Basé sur 3 heures/jour, 11¢/kWh. Les coûts dépendent du tarif et de la fréquence d'utilisation.	
<b>Life/Vie</b>	<b>22.8 years/ans</b>
Based on 3 hrs/day. /Basé sur 3 heures/jour.	
<b>Light Appearance/Apparence de l'éclairage</b>	
Warm/Chaud	Cool/Froid
2700K	
<b>Energy Used/Énergie utilisée</b>	<b>7 watts</b>

Item 1004523  
7W LED MR16, NFL25, SW27

<b>Lighting Facts/ Faits d'éclairage</b>	
Per Bulb/Par l'ampoule	
<b>Brightness/Luminosité</b>	<b>430 lumens</b>
<b>Estimated Yearly Energy Cost/ Coût énergétique annuel estimé</b>	<b>\$0.84</b>
Based on 3 hrs/day, 11¢/kWh. Cost depends on rates and use. /Basé sur 3 heures/jour, 11¢/kWh. Les coûts dépendent du tarif et de la fréquence d'utilisation.	
<b>Life/Vie</b>	<b>22.8 years/ans</b>
Based on 3 hrs/day. /Basé sur 3 heures/jour.	
<b>Light Appearance/Apparence de l'éclairage</b>	
Warm/Chaud	Cool/Froid
2700K	
<b>Energy Used/Énergie utilisée</b>	<b>7 watts</b>

Item 1004434  
7W LED MR16, FL40, SW27

<b>Lighting Facts/ Faits d'éclairage</b>	
Per Bulb/Par l'ampoule	
<b>Brightness/Luminosité</b>	<b>480 lumens</b>
<b>Estimated Yearly Energy Cost/ Coût énergétique annuel estimé</b>	<b>\$0.84</b>
Based on 3 hrs/day, 11¢/kWh. Cost depends on rates and use. /Basé sur 3 heures/jour, 11¢/kWh. Les coûts dépendent du tarif et de la fréquence d'utilisation.	
<b>Life/Vie</b>	<b>22.8 years/ans</b>
Based on 3 hrs/day. /Basé sur 3 heures/jour.	
<b>Light Appearance/Apparence de l'éclairage</b>	
Warm/Chaud	Cool/Froid
2700K	
<b>Energy Used/Énergie utilisée</b>	<b>7 watts</b>

3000K

Item 1004524  
7W LED MR16, SP15, WW30

<b>Lighting Facts/ Faits d'éclairage</b>	
Per Bulb/Par l'ampoule	
<b>Brightness/Luminosité</b>	<b>430 lumens</b>
<b>Estimated Yearly Energy Cost/ Coût énergétique annuel estimé</b>	<b>\$0.84</b>
Based on 3 hrs/day, 11¢/kWh. Cost depends on rates and use. /Basé sur 3 heures/jour, 11¢/kWh. Les coûts dépendent du tarif et de la fréquence d'utilisation.	
<b>Life/Vie</b>	<b>22.8 years/ans</b>
Based on 3 hrs/day. /Basé sur 3 heures/jour.	
<b>Light Appearance/Apparence de l'éclairage</b>	
Warm/Chaud	Cool/Froid
3000K	
<b>Energy Used/Énergie utilisée</b>	<b>7 watts</b>

Item 1004436  
7W LED MR16, NFL25, WW30

<b>Lighting Facts/ Faits d'éclairage</b>	
Per Bulb/Par l'ampoule	
<b>Brightness/Luminosité</b>	<b>480 lumens</b>
<b>Estimated Yearly Energy Cost/ Coût énergétique annuel estimé</b>	<b>\$0.84</b>
Based on 3 hrs/day, 11¢/kWh. Cost depends on rates and use. /Basé sur 3 heures/jour, 11¢/kWh. Les coûts dépendent du tarif et de la fréquence d'utilisation.	
<b>Life/Vie</b>	<b>22.8 years/ans</b>
Based on 3 hrs/day. /Basé sur 3 heures/jour.	
<b>Light Appearance/Apparence de l'éclairage</b>	
Warm/Chaud	Cool/Froid
3000K	
<b>Energy Used/Énergie utilisée</b>	<b>7 watts</b>

Item 1004435  
7W LED MR16, FL40, WW30

<b>Lighting Facts/ Faits d'éclairage</b>	
Per Bulb/Par l'ampoule	
<b>Brightness/Luminosité</b>	<b>480 lumens</b>
<b>Estimated Yearly Energy Cost/ Coût énergétique annuel estimé</b>	<b>\$0.84</b>
Based on 3 hrs/day, 11¢/kWh. Cost depends on rates and use. /Basé sur 3 heures/jour, 11¢/kWh. Les coûts dépendent du tarif et de la fréquence d'utilisation.	
<b>Life/Vie</b>	<b>22.8 years/ans</b>
Based on 3 hrs/day. /Basé sur 3 heures/jour.	
<b>Light Appearance/Apparence de l'éclairage</b>	
Warm/Chaud	Cool/Froid
3000K	
<b>Energy Used/Énergie utilisée</b>	<b>7 watts</b>

## CAUTION:

Lamp may not be compatible with all dimmers and transformers. Check [www.ushio.com](http://www.ushio.com) to find up to date dimmer and transformer compatibility options. Use only on 12V AC circuits. Do not open. No user serviceable parts inside. Suitable for damp locations. Suitable for use in recessed fixtures. Use is not recommended where exposed to weather. Outdoor usage requires an enclosed fixture. Meets UL 1993 safety rating for totally enclosed fixtures. Recommended lamp housing temperature is 150°F or below. Reliable operating environment temperature is -4°F to 113°F. Lamp is not intended for use with emergency exit fixtures, emergency exit lights, photo controls or electric timers. Lamp complies with Part 15 of the FCC Rules. Operation is subject to the following two conditions: (1) device may not cause harmful interference, and (2) device must accept any interference received, including interference that may cause undesired operation.

**USHIO**